

**Cooker hood**  
User Manual

HCB91845BX

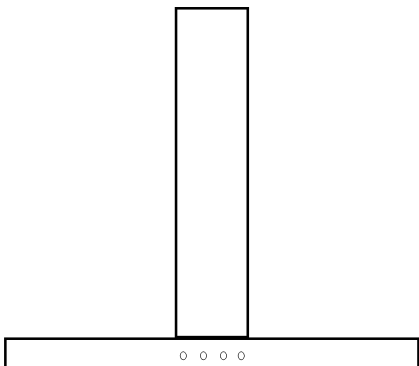

## Please read this user manual first!

Dear Customer,

Thank you for purchasing this Beko product. We hope that you get the best results from your product which has been manufactured with high quality and state-of-the-art technology. Therefore, please read this entire user manual and all other accompanying documents carefully before using the product and keep it as a reference for future use. If you handover the product to someone else, give the user manual as well. Follow all warnings and information in the user manual.

Remember that this user manual is also applicable for several other models. Differences between models will be identified in the manual.

### Explanation of symbols

Throughout this user manual the following symbols are used:

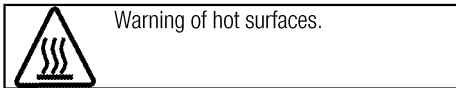
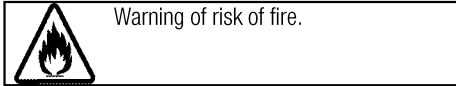
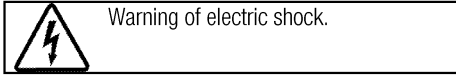
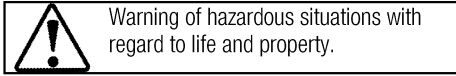
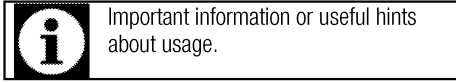

### Arçelik A.Ş.

Karaağaç caddesi No:2-6  
34445 Sütlüce/İstanbul/TURKEY

Made in TURKEY



---

This product was manufactured using the latest technology in environmentally friendly conditions.

## TABLE OF CONTENTS

### **1 Important instructions and warnings for safety and environment 4**

General safety .....	4
Electrical safety .....	4
Product safety .....	5
Intended use .....	6
Children's safety .....	6
Disposing of the old product .....	6
Package information .....	7

### **2 General information 8**

Overview .....	8
Scope of delivery .....	9
Technical specifications .....	9

### **3 Installation 10**

Installation .....	10
Future transportation .....	13

### **4 Operating the hood 14**

Controller .....	15
------------------	----

### **5 Maintenance and care 18**

General information .....	18
Replacing the lamp .....	18

### **6 Troubleshooting 19**

## **1 Important instructions and warnings for safety and environment**

This section contains safety instructions that will help protect from risk of personal injury or property damage. Failure to follow these instructions shall void any warranty.

### **General safety**

- Risk of Toxicating! While the appliance is operating, air in the entire house is sucked. If adequate ventilation is not provided, waste and toxic gasses which are released as a result of burning will be drawn back into the house through chimney draught. Do not operate the appliance together with sources that may emit toxic gasses and create air draught (wood, gas, oil, and coal stoves, water heaters, kettles, etc.).
- Always have the authorized persons check the adequacy of ventilation and chimney draught in your building.
- This appliance can be used by children aged from 8 years and above and persons with reduced physical, sensory or mental capabilities or lack of experience and knowledge if they have been given supervision or instruction concerning use of the appliance

in a safe way and understand the hazards involved.

Children shall not play with the appliance. Cleaning and user maintenance shall not be made by children without supervision.

- Always have the installation and repair procedures performed by Authorised Service Agent. Manufacturer shall not be held responsible for damages arising from procedures carried out by unauthorised persons.
- Do not operate the appliance if it is defective or has any visible damage.
- Make sure that the appliance is switched off after every use.
- Appliance must be installed by a qualified person in accordance with the regulations in force. Otherwise, the warranty shall become void.

### **Electrical safety**

- To get your product ready for use, firstly you must have installation place and electric wiring prepared. Later, you may call Authorised Service nearest to you.
- If it has a failure, the product should not be operated without being repaired by the Authorised

Service Agent. There is the risk of electric shock!

- Never plug the hood before installation is completed.
- Never touch the plug with wet hands! Do not unplug by pulling from the cable; always grab by the plug to unplug.
- Product must be disconnected from the mains during installation, maintenance, cleaning and repair procedures.
- If the power cable is damaged, it must be replaced by the manufacturer, after sales service or a similarly competent, certified person (preferably an electrician) or by a person to be defined by the importer firm.
- Never connect power cable near to the hobs. If melted down, cable may lead to fire.
- Any work on electrical equipment and systems may only be carried out by authorised and qualified persons.
- In case of any damage, switch off the product and disconnect it from the mains. To do this, turn off the fuse at home.
- Make sure that fuse current is compatible with the product.
- Never wash down the product with water! There is the risk of electric shock!

## Product safety

- The height between the lower surface of the hood and upper surface of the hob should not be less than 650 mm.
- Never touch the hood's lamp after they operated for a long time. Hot lamps may burn your hands.
- Never operate the product without oil filter. Never remove filters when the product is in use.
- Avoid big flames beneath the product. Otherwise, particles on oil filter may flame up and cause fire.
- Turn on the hobs after placing pans or pots on. Otherwise, rising temperature may deform certain parts of your product.
- Turn off the hobs before taking away pans or pots.
- Avoid inflammable materials under the hood.
- Do not expose the product to open flames beneath it. It can cause oils accumulated in the filter to catch fire. Do not operate the product without filter.
- Never leave the cooker unattended when frying foods, the oil may flame up and boiled oil may cause fire. Thus, be careful about cloths and curtains.
- If the hood is not periodically and properly cleaned, this may cause burning risk on your hood.

- For refreshing the kitchen's air from cooking smells and steams, please turn on your hood for 15 minutes more after cooking or frying has ended.
- When the hood is in use, especially together with gas cookers, please make sure that environment is ventilated with clean air.
- In the environment where the hood is being used, the exhaust of fuel oil or gas devices such as room heater must be absolutely insulated or device must be hermetical type.
- If there is a fuel oil or gas device in the environment, the room must be ventilated sufficiently.
- When a non-electrically operated device is concurrently used in the environment together with the hood, the negative pressure in the room must be maximum 0.4 mbar to avoid the hood's returning other device's exhaust into the room.
- Never connect the hood to the chimneys used for heaters, waste gas or with rising flames. Observe authorities' regulations on the draining of output air.
- When connecting to the chimney, use 120-mm diameter pipes. Pipe connection must be as short as possible with fewer bends.

- Do not hang easily flammable and combustible materials on hood handles.
- Our company shall never be responsible for the problems arising from the use against the warnings above.

### **Intended use**

This product is designed for domestic use. Commercial use is not admissible.

The manufacturer shall not be liable for any damage caused by improper use or handling.

### **Children's safety**

- Keep children away from the product when it is operating and do not allow them to play with the product.
- Packaging materials are dangerous to children. Keep the packaging materials in a place where children cannot reach and sort and discard them in accordance with the waste disposal directives.
- Electrical products are dangerous to children. Keep children away from the product when it is operating and do not allow them to play with the product.

### **Disposing of the old product**

**Compliance with the WEEE Directive and Disposing of the Waste Product:**



This product complies with EU WEEE Directive (2012/19/EU). This product bears a classification symbol for waste electrical and electronic equipment (WEEE).

This product has been manufactured with high quality parts and materials which can be reused and are suitable for recycling. Do not dispose of the waste product with normal domestic and other wastes at the end of its service life. Take it to the collection center for the recycling of electrical and electronic equipment. Please consult your local authorities to learn about these collection centers.

**Compliance with RoHS Directive:**

The product you have purchased complies with EU RoHS Directive (2011/65/EU). It does not contain

harmful and prohibited materials specified in the Directive.

**Package information**

- Packaging materials of the product are manufactured from recyclable materials in accordance with our National Environment Regulations. Do not dispose of the packaging materials together with the domestic or other wastes. Take them to the packaging material collection points designated by the local authorities.

## 2 General information

### Overview

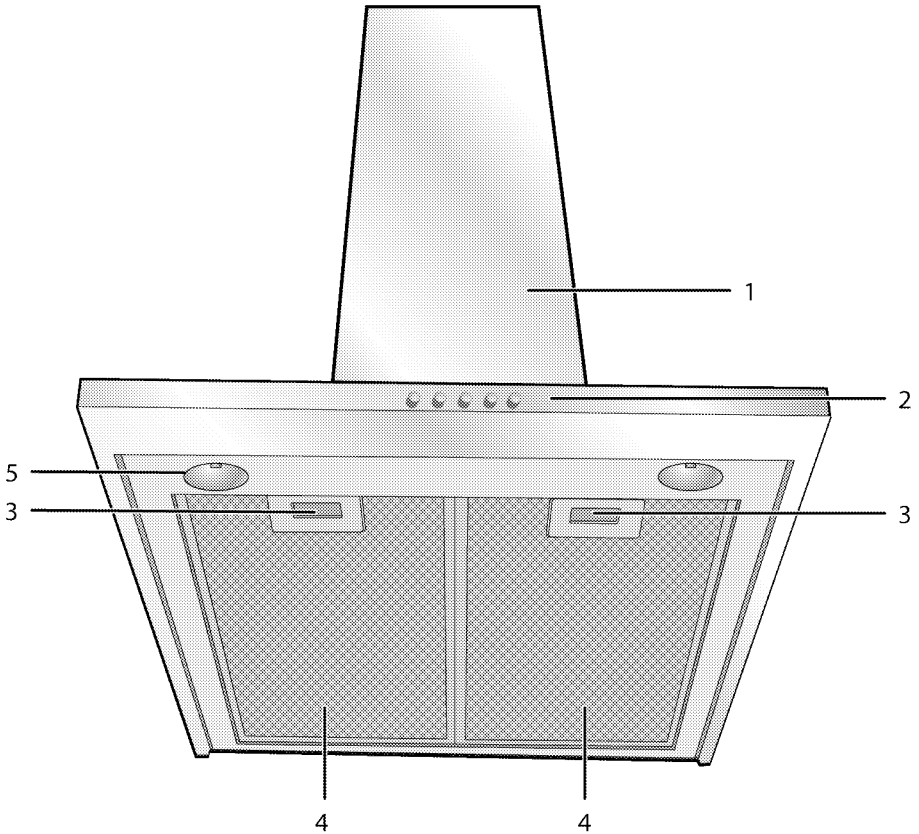

- 1 Hood body
- 2 Control panel
- 3 Aluminum filter lock
- 4 Aluminum filter
- 5 Lamp



## Scope of delivery



Accessories supplied can vary depending on the appliance model. Not every accessory described in the user manual may exist on your appliance.

1. User manual
2. Wall connector

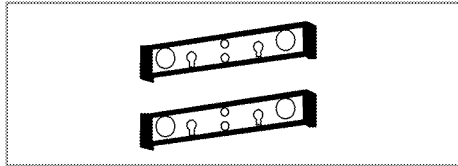

3. Air directing component optional

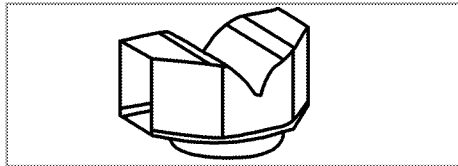

4. Chimney connection adapter

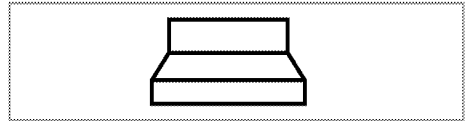

5. Valves to prevent reverse air flow



6. Distance ring



## Technical specifications

External dimensions (height/width/depth)	min. 760 mm max. 915 mm/898 mm/490 mm
Voltage/frequency	220-240 V ; 50Hz
Control	3 level + 1 Booster
Suction power	800 m <sup>3</sup> /h
Lamp power consumption	2 x 4 W / 2 x 1 W
Total power consumption	max. 225 W
Fuse	min. 10 A
Air outlet pipe diameter	120 mm



Technical specifications may be changed without prior notice to improve the quality of the product.



Figures in this manual are schematic and may not exactly match the product.



Values stated on the markings of the product or in other printed documents supplied with the product are obtained under laboratory conditions as per relevant standards. Depending on operational and environmental conditions of the product, these values may vary.

### 3 Installation

Refer to the nearest Authorised Service Agent for installation of the product. Make sure that the electric installations are in place before calling the Authorised Service Agent to have the product ready for operation. If not, call a qualified electrician and fitter to have the required arrangements made.



Preparation of location and electrical installation for the product is under customer's responsibility.



#### DANGER:

The product must be installed in accordance with all local electrical regulations.



#### DANGER:

Prior to installation, visually check if the product has any defects on it. If so, do not have it installed. Damaged products cause risks for your safety.

### Installation

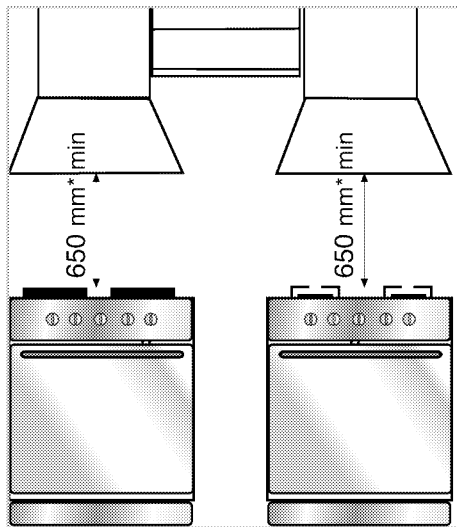

\* min.

The height between the lower surface of the hood and upper surface of the hob should not be less than 650 mm.

### Electrical connection

Manufactured with 2-track power cable, this device must be connected to the mains by an electrical switch with at least 3mm clearance between bipolar

contact leads. Have a qualified electrician to install electric wiring.

- Install your product to ensure easy access to electricity connection (plug, wall outlet) after installation.

### Installing the hood



Dimensions are given in mm.

Information required for the preparation of the installation place for your hood is given below. Hood should be placed as aligned by the central axis of the cooking appliance. Cooking appliance and the hood's oil filters should be at least 650mm away from each other. Perform the following steps for the installation of the hood.

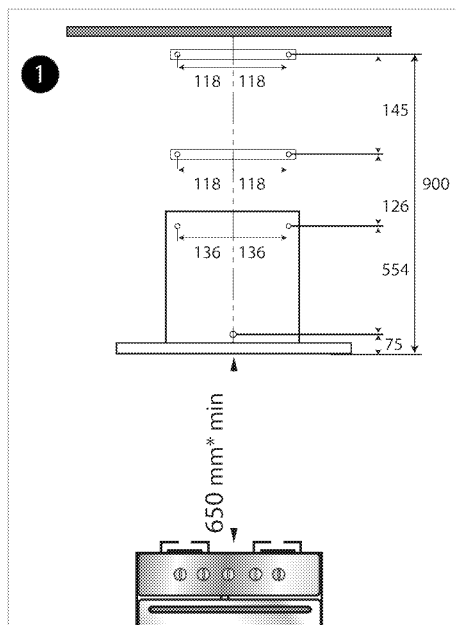

1. Centering the cooking appliance, draw an axis line on the wall up to 925 mm height. Then, taking this axis line as reference, drill 7 holes with 8 mm diameter according to the above measurement.
2. Insert the plastic plugs which are given with the packaging into these holes. Check whether the holes of the flue connection parts correspond to these holes or not.

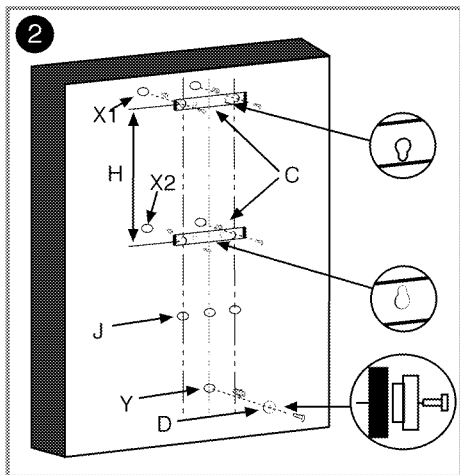

3. As shown in Figure 2, fix connectors (C) to the holes X1 and X2 via two fixing screws supplied with the accessories. Screw distance ring (D) on the Y hole as small-diameter side facing the wall.

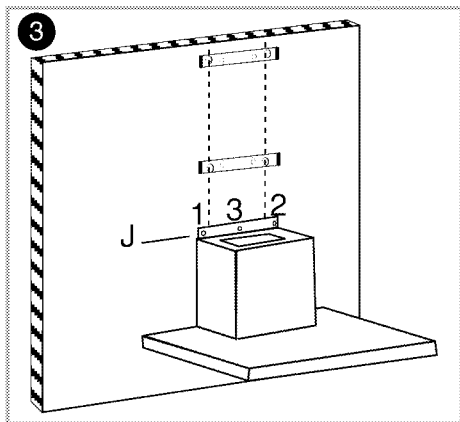

4. Install the hood from the key hole on back plate onto the distance ring and pull downward to make sure that it is secured. Then, screw the body onto the wall from the holes J1 and J2 on the upper back of the body. To avoid the hood falling down accidentally for any reason, screw it also from the hole J3 shown in Figure 3.

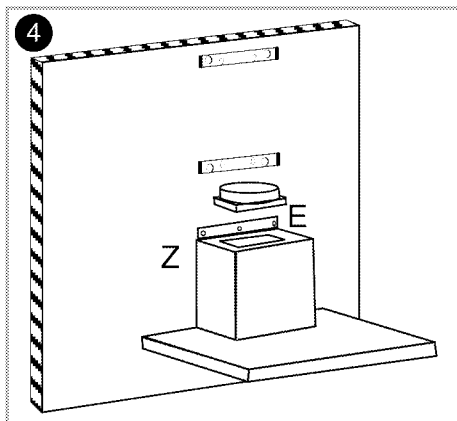

5. As shown in Figure 4, place chimney outlet flange (E) to the rectangular outlet on the upper part of the hood; and screw the flange onto the body using 2.9-mm traced screws supplied with accessories.
6. **For chimney connection usage:**  
In chimney-connected position, absorbed air will go through oil filters to the outlet and then will reach to the chimney through connection pipes and finally thrown out from the chimney.

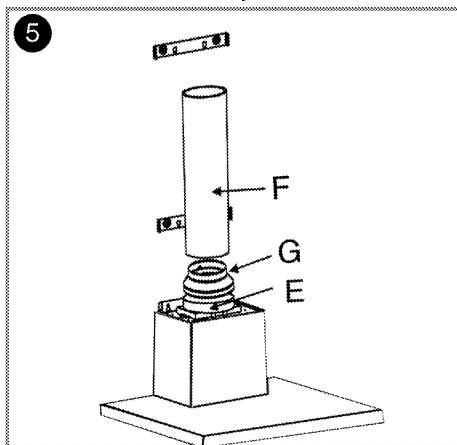

When using this connection position, 150mm to 120 mm E connector should be installed on chimney outlet flange as shown in Figure 5.

Chimney connection pipes must be made of fireproof plastic material. When using flexible connection type, it should be considered that sharp corners and sudden contractions will have a negative impact on air suction. Flue connection should in no way be made to any flue to which another device was already connected for another purpose.



Connection pipe should not be bigger than 120 mm; on the contrary, this application prevents proper chimney connection.

### 7. Internal circulation (Use with carbon filter)

Vacuumed air in the medium in the internal circulation position is delivered back to the medium from over the grills on the flue after it passes through the oil filters, the carbon filters where it is cleaned from odours, and the air deflector.

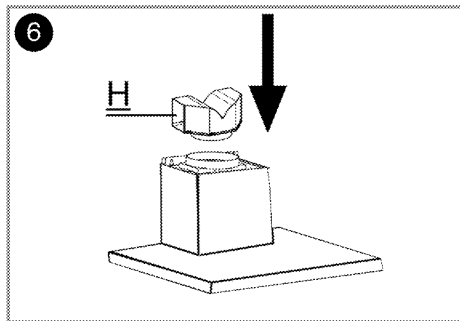

As shown in Figure 6, air directing component is installed on H point.

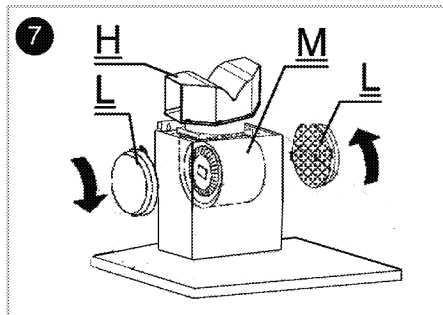

Place ear slots of carbon filters (L) to the ears on motor carrier (M) as shown in Figure 7 and turn anti-clockwise to fix in place. Apply the same procedure for the motor carrier on the other side.



In case of failure to perform cleaning and maintenance of oil filters regularly and when the carbon filter reaches its service life (about 4 months), there is the possibility of causing fire by them.

### 8. Flue installation

To install upper chimney A, secure the upper corners of the chimney on the connection (C) as shown below and screw it onto the connector with 2.9-mm screws.

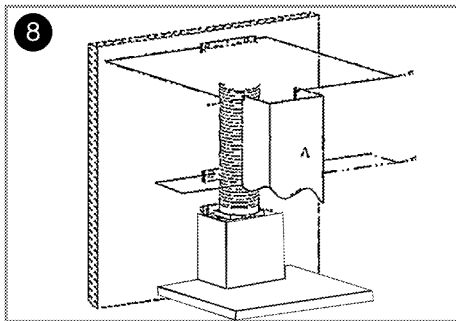

Distance between the hole X1 and X2 is determined during the installation process depending on the usage length of the upper chimney.

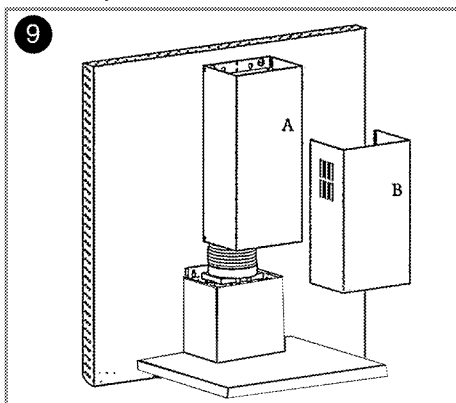

To install lower chimney B, stretch the chimney by pulling slightly from both sides and secure it onto upper chimney's slots as shown in the above figure.

### You can use your hood in two ways:

#### 1- Chimney-connected use

Vapors are discharged with the flue pipe secured on the connection ring on the hood. Diameter of the flue pipe should be equal to the diameter of connection ring. To allow the air easily going out of the room in horizontal arrangements, the pipe should be slightly tilted upwards (approximately 10°).



Carbon filter should be removed if it is installed in the hood.

#### 2- Use with no chimney connection

Air is filtered by the carbon filter and returned to the room. Carbon filter is used when there is no flue available in the house or when it is not possible to install the flue pipe.

- Connect the carbon filters as described in article 7 on installation chapter.

### **Future transportation**

- Keep the product's original carton and transport the product in it. Follow the instructions on the carton. If you do not have the original carton, pack the product in bubble wrap or thick cardboard and tape it securely.



Do not place any objects onto the product and move it in upright position.



Check the general appearance of your product for any damages that might have occurred during transportation.





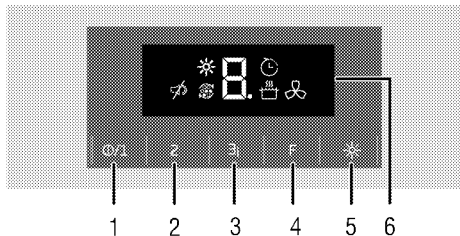

## 4 Operating the hood

Hood is equipped with a motor with various speed settings.

For a better performance, we advise you to use low speeds in normal conditions, and high speeds when smell and vapors are intensified.





- 1 On/off button / Speed1
- 2 Speed2
- 3 Speed3 / Booster
- 4 Function key
- 5 Lamp key
- 6 Display

-  Auto off symbol
-  Booster symbol
-  Filter full warning symbol
-  Air filter mode symbol
-  Quiet mode symbol
-  Lamp symbol

### Operating the hood

1. To turn on the hood, touch the on/off key.
2. To change the speed, touch Speed2 and Speed 3 keys.  
» Speed level of the hood shall be displayed.

 Do not touch both keys simultaneously. If touched, higher speed will be activated.

 Appliance operates for a maximum of 6 hours when no key is touched while it is operated.

### Auto off mode

1. Touch the function key when the appliance is operated at a certain speed. Auto off mode will be activated and  symbol is displayed.
2. Appliance shall be turned off automatically after operating for 20 minutes at the set level.

 Auto off mode is canceled when any level key other than the lamp key is pressed.

### Activating intense ventilation mode (Booster)

Touch the speed3 key for more than two seconds. Intense ventilation mode will be activated and P and  symbol shall be displayed, and the appliance will be active for maximum 10 minutes. After 10 minutes, it will continue to operate in Speed 3 position. During intense ventilation, if any of the speed keys is touched then the operation will continue in that speed level.

### Turning off the hood

1. Touch on the Off key when the hood is operating in a certain speed.  
» When the hood is being turned off, "0" is flashed on the display for 8 seconds while motor is being stopped. This is not an error.

### Operating the lamp

1. Touch the lamp key to turn on the lamp. Lamp illuminates and  symbol is displayed.

### Turning off the lamp

1. Touch the lamp key again to turn off the lamp. Lamp is turned off and the  symbol on the display disappears.

 Off key does not turn off the lamp, it only stops operation of the hood.

### Air filter mode

1. Touch the function key when the appliance is not operated at any speed.  
» Air filter mode will be activated and C and  symbol is displayed.
2. Air filter mode will operate for 10 minutes at speed 1 level and then stops for 50 minutes within 1 hour. If the air filter mod will not turned off, it will continue to operate for 10 minutes and stops 50 minutes for each each hour during 24 hours.

**i** You can utilize air filter mode to remove odor found in-house in long term using low speed.

### Turning off the air filter mode

1. Turn off the air filtering mode by touching any speed key or touching the off key while the air filtering mode is active.

**i** While the air filter mode is active, when you turn on and off the appliance at any speed level, air filter mode shall not be remembered.

**i** While the air filter mode is active, the program will be canceled if there is a blackout.



### Filter full warning

After every 100 hours operation, F symbol and the set level flashes in turn on the display. Also,  symbol appears on display. Clean your filter. Filter full warning will not reset automatically after cleaning.

Filter full warning may be reset by pressing function and speed3 buttons for 3 seconds simultaneously.

**i** When the hood gave filter full warning, the warning will not be reset if there is a blackout.

### Quiet mode









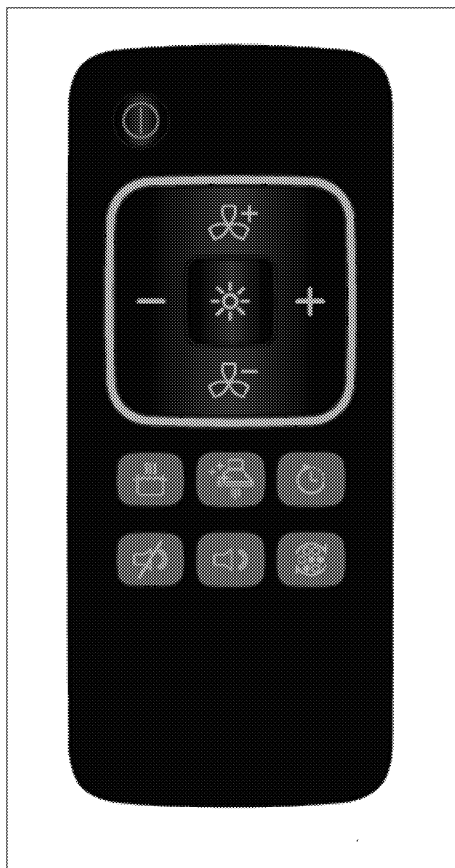

You may prevent key clicks from the hood by activating the quiet mode. Touch the function key until  symbol is displayed to switch to quiet mode. Touch the function key until  symbol is disappeared from the display to cancel the quiet mode.

### Controller

You may also control your appliance with the remote controller.

The dot sign on the display flashes twice for each operation of the controller keys when the hood is operated with the controller



-  On/off button
-  Increase speed button
-  Decrease speed button
-  Air filter mode button
-  Auto off button
-  Booster button
-  Filter full warning off button
-  Quiet mode button
-  Quiet mode cancel button
-  Lamp button

## Operating the hood with the controller

1. To turn on the hood, touch the on/off key on the controller.
  - » Hood starts to operate at speed 1.
2. Press Speed increase and/or Speed decrease buttons to change the speed level.
  - » Speed level of the hood shall be displayed.



Never press on two buttons at the same time.





Appliance operates for a maximum of 6 hours when no button is pressed while it is operated.

## Turning off the hood with the controller

1. Press on the on/off key on the controller when the hood is operating in a certain speed.
  - » When the hood is being turned off, "0" is flashed on the display for 8 seconds while motor is being stopped. This is not an error.



## Turning the auto off mode on with the controller

1. Press the  button on the controller while the appliance is operated at a certain speed. Auto off mode will be activated and  symbol is displayed.
2. Appliance shall be turned off automatically after operating for 20 minutes at the set level.



Auto off mode is canceled when a speed level other than the level that the appliance is being operated is set.

## Activating intense ventilation mode (Booster) with the controller

Press the  button on the controller while the appliance is operated at any speed level. Intense ventilation mode will be activated and P and  symbol shall be displayed, and the appliance will be active for maximum 10 minutes. After 10 minutes, it will continue to operate in Speed 3 position. Press speed increase or decrease buttons to quit the intense ventilation mode. Operation will continue in the selected speed level.

## Operating the lamp with the controller

1. Press on the button  to operate the lamp.
  - » Lamp illuminates and  symbol is displayed.

## Turning off the lamp with the controller

1. Press on the lamp  again to turn off the lamp.

» Lamp is turned off and the  symbol on the display disappears.



You may turn the lamp on and off while hood is turned off.



On/Off button does not turn off the lamp, it only stops operation of the hood.

## Turning the air filtering mode on with the controller

1. When the appliance is not operated, press button without pressing on/off button on the controller.
  - » Air filter mode will be activated and C and  symbol is displayed.
2. Air filter mode will operate for 10 minutes at speed 1 level and then stops for 50 minutes within 1 hour. If the air filter mode will not be turned off, it will continue to operate for 10 minutes and stops 50 minutes for each each hour during 24 hours.



You can utilize air filter mode to remove odor found in-house in long term using low speed.

## Turning the air filtering mode off with the controller

1. Turn off the air filtering mode by pressing speed increase, on/off key or  key while the air filtering mode is active.



While the air filter mode is active, when you turn on and off the appliance at any speed level, air filter mode shall not be remembered.



While the air filter mode is active, the program will be canceled if there is a blackout.

## Turning off the filter full warning with the controller

After every 100 hours operation, F symbol and the set level flashes in turn on the display. Also,  symbol appears on display. Clean your filter. Filter full warning will not reset automatically after cleaning.







Press the  button on the control to turn off the filter full warning.



When the hood gave filter full warning, the warning will not be reset if there is a blackout.

### Activating the quiet mode with controller

You may prevent key clicks from the hood by activating the quiet mode. Press the  button on the controller to switch to quiet mode.  Symbol appears on display. Press  button to activate key clicks by canceling the quiet mode.  symbol disappears.

### Replacing the battery of the controller

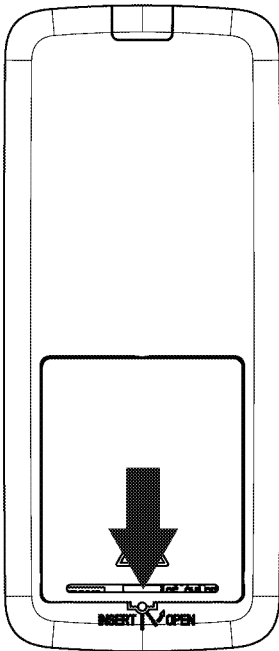

1. Remove the cover from the point indicated with arrow and open the battery compartment.
2. Place the CR2016 type battery.
3. Close the cover of battery compartment.



Batteries may be dead if your appliance does not react completely to the commands given by the controller. Discharged batteries shall never be kept in battery compartment.



Manufacturer shall not be held responsible for damages caused by used batteries.

### Note on the environment



This symbol, available on the battery or on the product package, indicates that the battery delivered with this product shall not be considered as universal waste. This symbol may be used with a chemical symbol on some batteries. HG chemical symbol is added if the amount of mercury in the batteries is higher than 0.0005%; and Pb chemical symbol is added if the amount of lead in the batteries is higher than 0.004%. Including the ones without heavy metals, batteries shall not be disposed with household waste. Please dispose of used batteries in an environmentally friendly manner. Learn the regulations in your local area.

## 5 Maintenance and care

### General information

Service life of the product will extend and frequent problems will decrease if the product is cleaned at regular intervals.

 **DANGER:**  
Disconnect the product from mains supply before starting maintenance and cleaning works.  
There is the risk of electric shock!

- Clean the product thoroughly after each use. In this way it will be possible to remove cooking residues more easily, thus avoiding these from burning the next time the appliance is used.
- No special cleaning agents are required for cleaning the product. Use warm water with washing liquid, a soft cloth or sponge to clean the product and wipe it with a dry cloth.
- Do not use cleaning agents that contain acid or chloride to clean the stainless or inox surfaces and the handle. Use a soft cloth with a liquid detergent (not abrasive) to wipe those parts clean, paying attention to sweep in one direction.

 The surface might get damaged by some detergents or cleaning materials.  
Do not use aggressive detergents, cleaning powders/creams or any sharp objects during cleaning.

 Do not use steam cleaners for cleaning.

### Aluminum filter

This filter captures oil particles in the air. You are recommended to clean your filter once a month in normal use. Please firstly remove aluminum filters for this process. Wash the filters in liquid-detergent water and install them after drying. Aluminum filters might change colour in time due to washing. This is normal and you don't need to replace the filter.

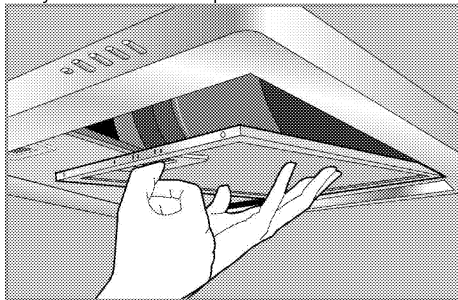

 You can also wash aluminum filters in dishwasher.

### Removing aluminum filters

1. Push aluminum filter lock forward.
2. Slightly lower the filter and pull forth. Otherwise, you may bend the filter.
3. After washing, reverse the steps above to re-install the aluminum filter.

### Carbon filter (Use without chimney)

 Carbon filter should never be washed.

It should be replaced once every 4 months in normal use. You may obtain carbon filters from the Authorised Service.

### Replacing the lamp

 **DANGER:**  
Before replacing the lamp, make sure that the product is disconnected from mains in order to avoid the risk of an electrical shock. If hot, let the lamp cool down.  
Hot surfaces may cause burns!

 For the specifications of the lamp, see *Technical specifications, page 9*. Oven lamps can be obtained from Authorised Service Agents.

 Position of lamp might vary from the figure.

1. Remove the lamp pressing it towards its seat in clockwise direction (1) and then remove turning it in counterclockwise direction (2).

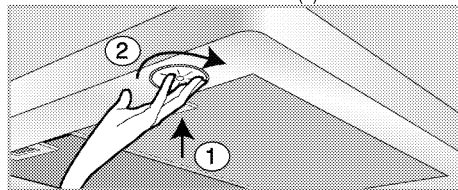

2. Insert the new lamp turning it in clockwise direction.
3. A "click" will be heard when the lamp is secured in its place.

## 6 Troubleshooting

### **Product does not operate.**

- The mains fuse is defective or has tripped. >>> *Check fuses in the fuse box. If necessary, replace or reset them.*
- Product is not plugged into the socket. >>> *Check the plug connection.*
- Speed button might not be set. >>> *Press the required speed button.*
- Power is cut. >>> *Check if there is power. Check the fuses in the fuse box. If necessary, replace or reset the fuses.*

### **Hood light does not work.**

- Hood lamp is defective. >>> *Replace the hood lamp.*
- Power is cut. >>> *Check if there is power. Check the fuses in the fuse box. If necessary, replace or reset the fuses.*



Consult the Authorised Service Agent or the dealer where you have purchased the product if you cannot remedy the trouble although you have implemented the instructions in this section. Never attempt to repair a defective product yourself.

